

KRIPSOL®

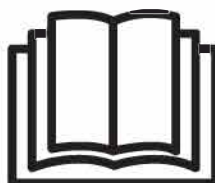
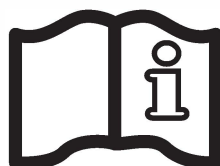

KLX

OWNER'S MANUAL

KRIPSOL®

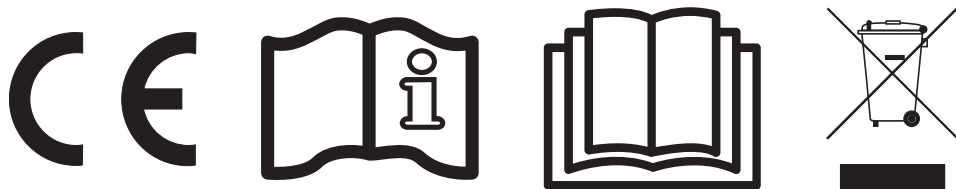

KLX

PLEASE KEEP THIS MANUAL FOR FUTURE REFERENCE



WARNING: Electrical hazard.
Failure to comply with these instructions can result
in serious injuries or death.
THE EQUIPMENT IS INTENDED TO BE USED ONLY
IN SWIMMING POOLS

⚠ WARNING – Disconnect the equipment from the mains supply before any intervention.

⚠ WARNING – All electrical connections must be carried out by a qualified approved electrician in accordance with the standards currently in force in the country of installation.

F	NF C 15-100	GB	BS7671:1992
D	DIN VDE 0100-702	EW	SIST HD 384-7-702.S2
A	ÖVE 8001-4-702	H	MSZ 2364-702:1994 / MSZ 10-533 1/1990
E	UNE 20460-7-702 1993, REBT ITC-BT-31 2002	M	MSA HD 384-7-702.S2
IRL	IS HD 384-7-702	PL	TS IEC 60364-7-702
I	CEI 64-8/7	CZ	CSN 33 2000 7-702
LUX	384-7.702 S2	SK	STN 33 2000-7-702
NL	NEN 1010-7-702	SLO	SIST HD 384-7-702.S2
P	RSIUEE	TR	TS IEC 60364-7-702

⚠ WARNING – Check that the device is plugged into a power outlet that is protected against short-circuits. The device must also be powered via an isolating transformer or a residual current device (RCD) with a nominal operating residual current not exceeding 30 mA.

⚠ WARNING – Ensure that children cannot play with the device. Keep your hands and any foreign object away from openings and moving parts.

⚠ WARNING – Check that the supply voltage required by the product corresponds to the voltage of the distribution network and that the power supply cables are suitable for the product power supply.

⚠ WARNING – Chemicals can cause internal and external burns. To avoid death, serious injury and/or damage to equipment, wear personal protective equipment (gloves, goggles, mask, etc.) when servicing or maintaining this device. This device must be installed in an adequately ventilated place.

⚠ WARNING – To reduce the risk of electric shock, do not use an extension cable to connect the device to the mains. Use a wall socket.

⚠ WARNING – Chemicals can cause internal and external burns. To avoid death, serious injury and/or damage to equipment, wear personal protective equipment (gloves, goggles, mask, etc.) when servicing or maintaining this device. This device must be installed in an adequately ventilated place.

⚠ WARNING – To reduce the risk of electric shock, do not use an extension cable to connect the device to the mains. Use a wall socket.

⚠ WARNING – Carefully read the instructions that appear in this manual and on the device. Failure to comply with the instructions can cause injuries. This document must be given to every pool user, who should keep it in a safe place.

⚠ WARNING – This appliance can be used by children aged 8 years and over and by people with reduced physical, sensory or mental capabilities, or those who lack experience or knowledge, if they are supervised correctly or if they have been given instructions concerning safe use of the appliance and understand the hazards involved. Children must not play with the device. User maintenance and cleaning must not be carried out by unsupervised children.

⚠ WARNING – Use only original Kripsol parts.

⚠ WARNING – If the power supply cable is damaged, it must be replaced by the manufacturer, the after-sales service or similarly qualified persons to avoid danger.

⚠ WARNING – The device must not be used if the power cord is damaged. An electric shock could occur. A damaged power cord must be replaced by the after-sales service or similarly qualified persons to avoid danger.

USE ONLY GENUINE REPLACEMENT PARTS

From 3 g salt/l

Upgrade possible

Worldwide remote control

WiFi and MODBUS

Self-cleaning

Sea water

1. UNIT DESCRIPTION

Water treatment system and controller for swimming pools.

Water treatment: Chlorine is produced by electrolysis of salt water, using salt water of low salinity. Production of sodium hypochlorite (liquid chlorine) in the electrolysis cell is achieved with a minimum of 3g salt per litre. The chlorine combats and eliminates bacteria, viruses and pathogenic agents, and oxidizes organic matter present in the water. The used sodium hypochlorite reconverts into salt after a few hours. The system centralises control of all pool equipment, optimising interactions between the various installations.



ELECTRONIC BOX

(A)	Main connection 230 V - 50 Hz
(B)	Cell connection
(C)	Options connections
(D)	pH and Rx connection
(E)	ON/OFF switch

Weight: 5.8 kg



CELL

(A)	Electrolysis cell
(B)	Connection to unit
(C)	Cell housing
(D)	Flow/gas detector (internal)

2. UNIT INSTALLATION

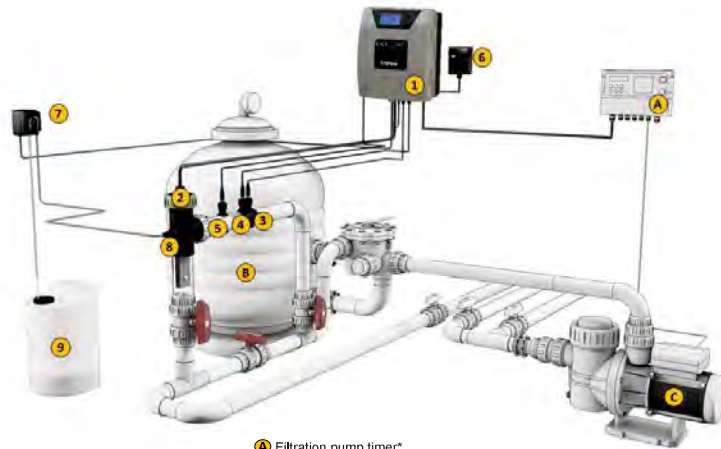

- Ⓐ Filtration pump timer*
- Ⓑ Sillex / glass / diatom filter
- Ⓒ Recirculation pump
- ① Electronic box
- ② Electrolysis cell (always vertical)
- ③ pH probe (optional)
- ④ Rx probe (optional)
- ⑤ Temperature probe (optional)
- ⑥ WiFi module (optional)
- ⑦ Acid dosing pump (optional)
- ⑧ Acid injector (optional)
- ⑨ Hydrochloric acid container (not supplied)

Electricity consumption

Use of a 16 A time delay circuit breaker is recommended for KLX devices. Where the power supply is shared with other devices, please consult a technician for correct sizing of your installation.

Product	Maximum Consumption	g Cl ₂ /h
KLX 8	80 W	8
KLX 16	130 W	16
KLX 22	145 W	22
KLX 33	165 W	33
KLX 50	210 W	50

⚠️ *Filtration control by external timer



⚠️ *Filtration control by internal timer

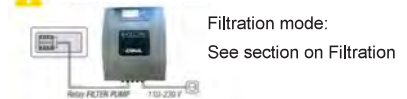

USE ONLY GENUINE REPLACEMENT PARTS

2.1. UNIT ASSEMBLY



Rubber hinge
X2



Rubber stopper
for hinges X2



Rawlplug
X4

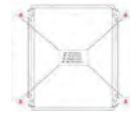

Drilling template
X1



Wall screw
X4



Suspension eye
X4



Screw for suspension eye
X4

- Step 1. Without opening the unit cover, screw the 4 suspension eyes to the box from behind.
- Step 2. Mark the positions of the 4 eyes using the drilling template.
- Step 3. Drill and insert the 4 rawlplugs into the wall.
- Step 4. Screw in the 4 wall screws and hang up the unit.

2.2. PH and REDOX CHIP ASSEMBLY

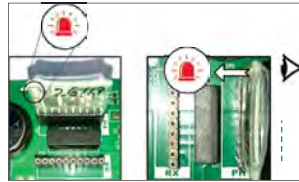

2.3. ASSEMBLY AND CONNECTION OF THE CELL

1. Install the cell in a vertical position
2. Install the cell on by-pass
3. Install the cell at the highest point of the installations
4. Connect the cell and the gas detector to the electronic box

N.B.:

If the unit is being installed for a pool that has already been treated with chlorine, we recommend total renewal of all water in the pool so that the cyanuric acid (chlorine stabiliser) does not distort measurements made by the rX (redox) probe.

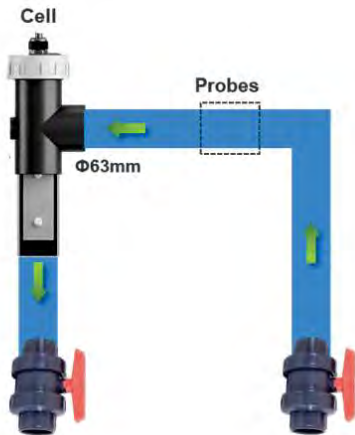

USE ONLY GENUINE REPLACEMENT PARTS

3. ELECTRONIC ANEL FOR ELECTRICAL CONNECTIONS

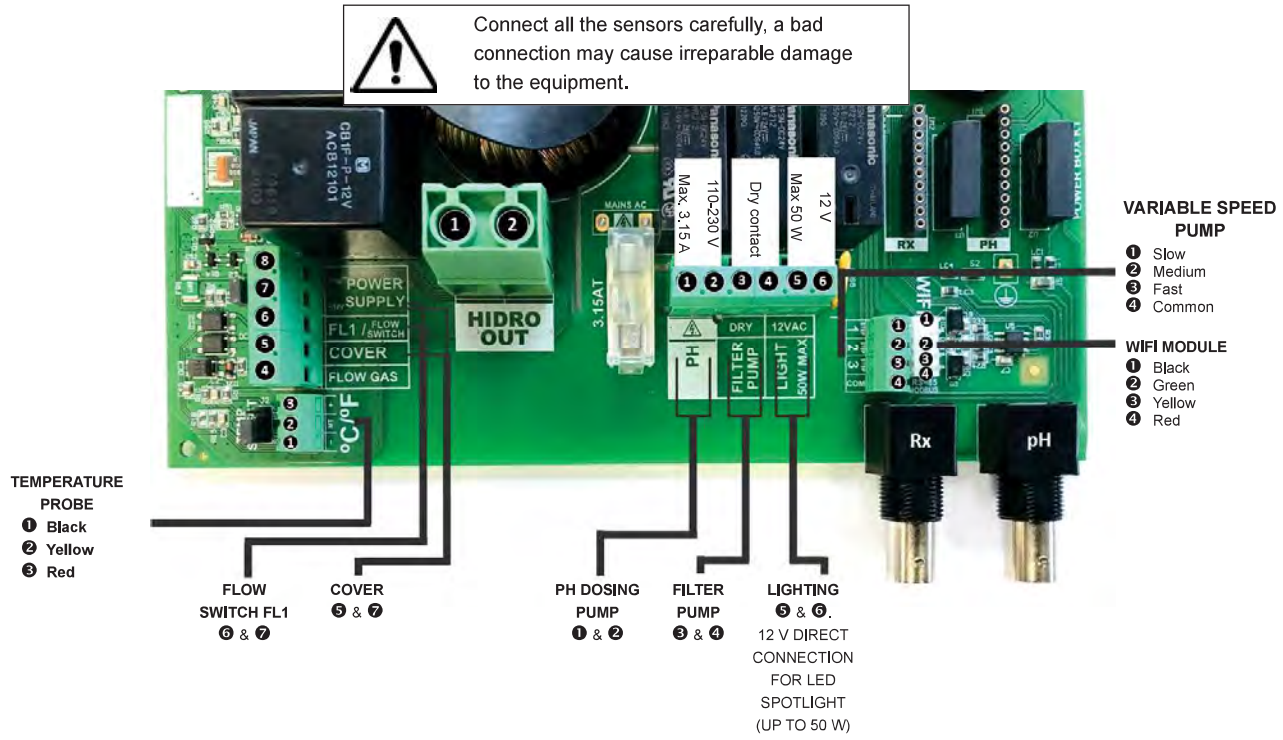

4. MAIN SCRE

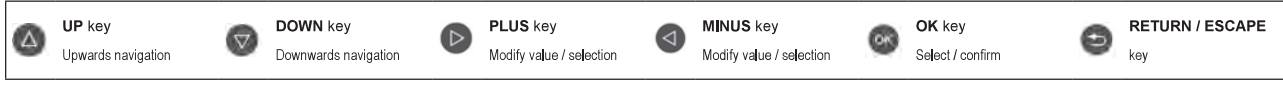
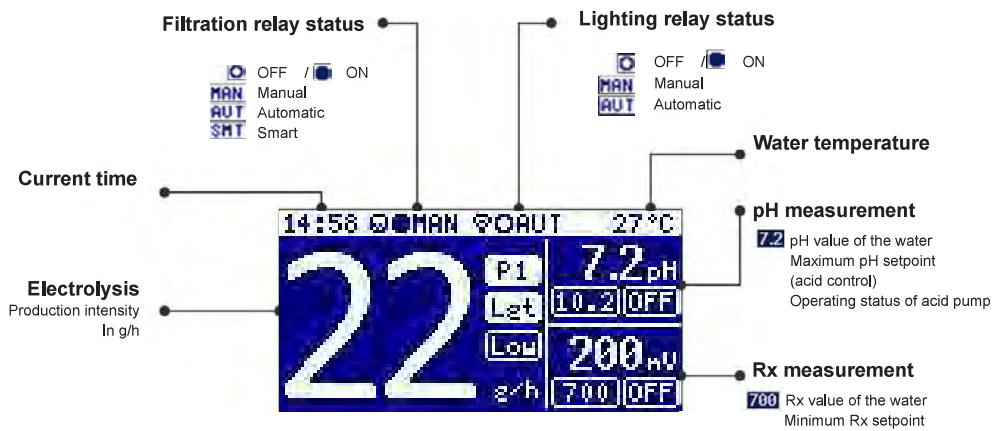

USE ONLY GENUINE REPLACEMENT PARTS

5. ELECTROLYSIS

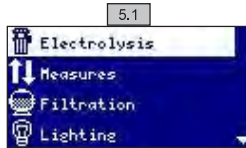

5.1 Electrolysis:
Programming of electrolysis functions.



5.2 Level:
Desired chlorine production (g/h).

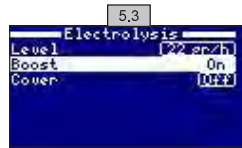

5.3 Boost (superchlorination):
Filtration for 24h at maximum intensity. Automatic return to programmed filtration mode. During the boost period the Rx control can be deactivated.

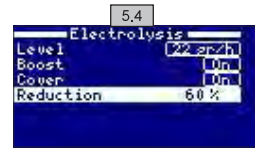

5.4 Cover:
Reduction of chlorine production activated by closing the automatic cover. See section on Cover.



6. MEASUREMENTS / Setpoints

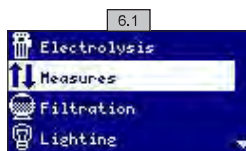

6.1 Measurements:
Adjustment of setpoints and measuring probes.

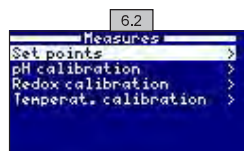

6.2 Setpoints for each measurement:

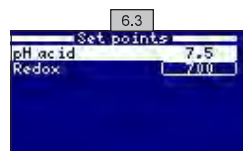

6.3 Setpoint settings:
configuration of the ideal levels for each parameter.



Default values:

- pH: 7.3 – 7.5
- Rx: 600 – 800

6.1. MEASUREMENTS – pH calibration



Measurement and control of the pH of the water

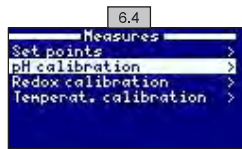

6.4 Calibration of pH probe:
Recommended every month during the season of use.

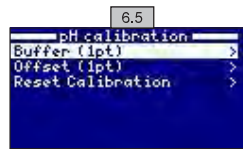

6.5 Calibration with buffers (buffer solutions pH7 / pH10 / neutral): Follow the 7-step instructions that are shown on the display.

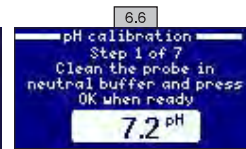

6.6 Example of first step of calibration with buffers. Continue with the following steps.

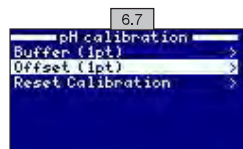

6.7 Manual calibration: Allows adjustment of the probes to 1 objective measurement (without buffers) – only recommended for correction of small deviations in the readings.



6.8 Without removing the probe from the water, use the plus / minus keys to adjust the reading so it matches with your reference value (photometer or other measuring device).



USE ONLY GENUINE REPLACEMENT PARTS

6.2. MEASUREMENTS – Rx calibration

The Rx value gives information about the oxidation/reduction potential and is used to determine the water sterilization capacity. The setpoint is the minimum Rx value for activation/deactivation of the titanium cell. Adjusting the ideal Rx level (setpoint) is the last step in the system set-up. Follow these steps to determine the ideal Rx levels for your pool:

1. Connect your pool filtration system (the salt in the pool must be completely dissolved).
2. Add chlorine to the water until a level of 1-1.5 ppm is reached (approx. 1-1.5 g/m³ water). pH levels should be between 7.2 – 7.5.
3. After 30 minutes take a reading of the free chlorine level in the pool (manual test kit DPD1). If the free chlorine level is in the range 0.8 – 1.0 ppm, look at the value on the Rx display and put this value into the memory as the setpoint to activate/deactivate the electrolysis/hydrolysis cell.
4. The next day check the levels of free chlorine (manual test kit DPD1) and Rx. Raise/lower setpoint if necessary.
5. Remember to check the Rx setpoint every 2-3 months and/or when the water parameters change (pH/temperature/conductivity).

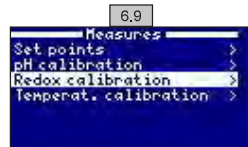

6.9 Calibration of Rx probe:
Recommended every 2 months during the season of use.

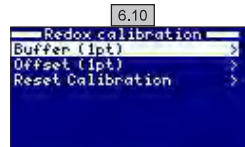

6.10 Calibration with buffer (buffer solution 465 mV): Follow the 4-step instructions that are shown on the display.



6.11 Example of first step of calibration with buffers. Continue with the following steps.

Measurement and control of Rx as the control value of free chlorine

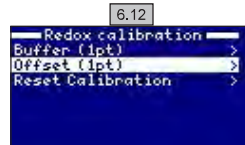

6.12 Manual calibration: Allows adjustment of the probes to 1 objective measurement (without buffers) – only recommended for correction of small deviations in the readings.

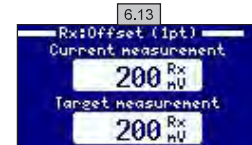

6.13 Without removing the probe from the water, use the plus / minus keys to adjust the reading so it matches with your reference value (photometer or other measuring device).

6.3. MEASURES – Temperature calibration

Temperature probe necessary to activate the smart filtration mode

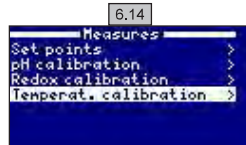
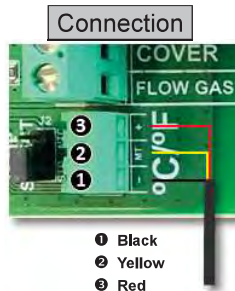

6.14 Temperature calibration.

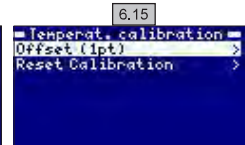

6.15 Manual calibration: Allows adjustment of the probes to 1 objective measurement.

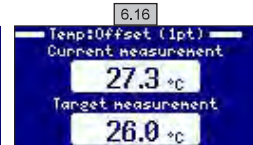

6.16 Use the plus / minus keys to correct the difference between the measured value of the probe and the actual temperature. Set to the actual temperature of the probe and press OK.

USE ONLY GENUINE REPLACEMENT PARTS

7. FILTRATION – Manual mode

Connection



Dry contact

For set-up and connection of a **Variable Speed Pump**, see section on Filtration / Variable Speed Pumps.

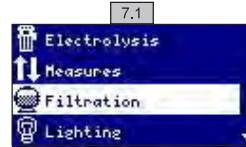

7.1 Filtration:

Configuration of the filter pump control. To configure this, select Filtration and confirm by pressing OK. A mode is selected from the Mode listing, using the plus/minus keys.



7.2 Manual:

Manually turns the filtration process ON or OFF. No timing or additional functions. The Status line indicates whether the filtration pump is ON or not. See section Filter Cleaning below.

7.1. FILTRATION – Automatic mode



7.3 Automatic (or with timer):

In this mode the filtration is switched on in accordance with timers that allow adjustment of the start and end times of the filtration. Timers always operate daily, in cycles of 24 hours.

To set the ON/OFF times (configuration of up to 3 times possible), use the up/down keys in the timer line that you want to change (1-3).

Open the start time input field for the selected timer using the plus/minus keys. Set the time with plus/minus keys. Use the up key to scroll up to the minutes input field and set this using plus/minus keys. To confirm press OK and to cancel press return/escape. To set the OFF timer, proceed in the same way.

See section Filter Cleaning below.

7.2. FILTRATION – Smart mode

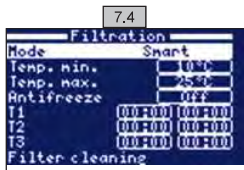

7.4 Smart*: This mode is based on the automatic or timer mode, with its 3 filtration intervals, but with adjustment of the filtration times as a function of the water temperature. Two temperature parameters are provided for this: the maximum temperature, above which the filtration times will be those set by the timers, and the minimum temperature, below which the filtration time will be reduced to 5 minutes, which is the minimum operating time. Between these 2 temperatures the filtration times increase linearly. Use the plus/minus keys to set the desired minimum and maximum temperatures. There is the option of activating the antifreeze mode which sets the filtration to run continuously if the water temperature is below 2 °C.

To set the ON/OFF times (configuration of up to 3 times possible), follow the instructions for the Automatic Mode.

See section Filter Cleaning below.

* **N.B.:** Mode only visible when the option to use temperature probe and/or heating is activated in the "Installer Menu".

7.3. FILTRATION – Filter cleaning



7.5 Filter cleaning mode (and pool cleaning by suction): From this menu (accessible from any Filtration Mode) a backwash cleaning of the sand filter can easily be carried out. Activating this menu from any filtration mode (Manual, Automatic, Smart), will disconnect the electrolysis/hydrolysis cell.

Then proceed as follows:

- Turn the filter pump OFF using the plus/minus keys.
- Place the filtration pump valve in the backwash cleaning position.
- Turn the filtration pump back ON. You can check the duration of the backwash cleaning by looking at the clock on the screen. Make sure an adequate and complete backwash of your filter has been carried out.
- When you have finished the backwash cleaning, again turn the filtration pump OFF and put the valve back in the filtering position. If you wish, you can now perform a rinse cycle.
- Proceed in the same way as for backwash cleaning, this time placing the filtration pump valve in the rinsing position.
- When exiting the Filter Cleaning menu using the return/escape key, the system will revert back to the mode programmed previously.

USE ONLY GENUINE REPLACEMENT PARTS

8. LIGHTING

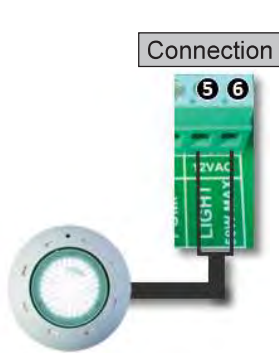

Output: 12 V
Max 50 W

12 V direct connection
for LED spotlight
(Up to 50 W)

No need to use an
electrical panel
or independent
transformer.

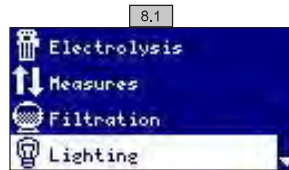

8.1 Lighting



8.2 Manual ON / OFF mode.



8.3 Automatic Mode: Sets the ON/OFF times for the lights. The timers can be configured with the following frequencies: daily; every 2 days; every 3 days; every 4 days; every 5 days; weekly; every 2 weeks; every 3 weeks; every 4 weeks.



8.4 LED spotlights: If your pool has LED spotlights, use this menu to configure the lighting.



8.5 Colour selection: Using this menu you can change the colour of the lights in your pool. The *Next Program* option will manually program the colour change, and using the *Pulse Length* option you can select the frequency required to change the colour.



Do not connect:
- Halogen spotlight.
- Spotlights with a
power consumption
greater than 50 W.

9. PH PUMP RELAY



110 – 230 V
Max. 1,15 A

Acid dosing pump:

- The pump turns on in response to the setpoint that was configured in the menu entitled Measurements - Setpoints - acid pH (setpoint < pH value of the water).
- In the standard menu, the maximum dosing time is 60 minutes to avoid acidification of the water (AL3).
- It can dose either acid or alkali (please contact your supplier).

USE ONLY GENUINE REPLACEMENT PARTS

10. SYSTEM SETTINGS – Manual mode

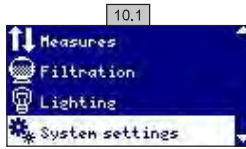

10.1 System settings.



10.2 Sets the language.

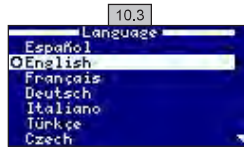

10.3 Choose your preferred language.



10.4 Sets the current date and time.

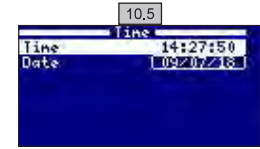

10.5 Enter the current date and time.



10.6 Sets the screen configuration.



10.7 Sets the lighting intensity of the screen display (0-100%) and programs its ON/OFF timers.



10.8 Sound settings.

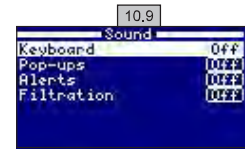

10.9 Sound: Programming the system to emit sounds for the following functions: Keyboard (keys); Notices (pop-up message); Alarms (operating alarm); Filtration (start of filtration).

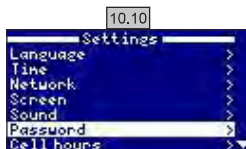

10.10 Sets the password.



10.11 Password: Protects user access to the menu by activating a password. Press a combination of 5 keys and the system will memorize it. If you forget the password, there is a 'master password'. Ask your installer/supplier.

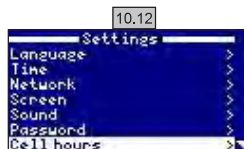

10.12 Cell timings: Counters of time of operation for the various modules.

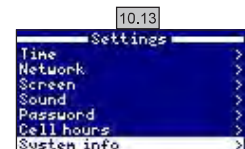

10.13 System information

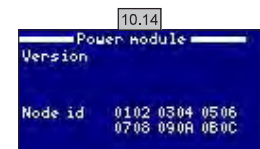

10.14 System information: Information about the software versions of the TFT display and the power module. It also shows the ID node which is required to configure the system's WIFI connection.

10.1. WIFI CONFIGURATION

Connection



WIFI MODULE

- 1 Red
- 2 Yellow
- 3 Green
- 4 Black

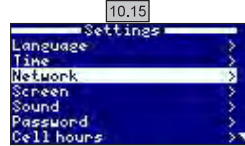

10.15 Internet: Once the WIFI module is connected, restart your unit. The Internet option will appear in the Settings menu.



10.16 WIFI: Select WIFI to scan for available networks that the module can access. The search will be carried out automatically.



10.17 Select the desired network that the WIFI module can access. Enter the password in the pop-up keyboard. Scroll up and down with the up/down keys and left to right with the plus/minus keys. To select a letter press OK.

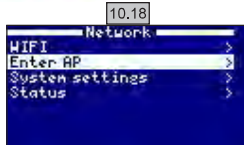

10.18 Select AP: Manually enter the name and the password of the network selected.



10.19 System settings: For a more detailed configuration enter into this menu or contact your installer.

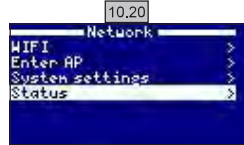

10.20 Status: Check the status of your connection.

Once the WIFI module has been connected to the network and both lights are ON, go to www.kripsolpool.com. Access the Register option and enter all the data requested. The unit ID node can be found on your device (see section 10. System Settings - screens 10.13 & 10.14). Upon completion of the process, you will have total control over your pool and you will be able to change parameters such as setpoints or filtration times.

USE ONLY GENUINE REPLACEMENT PARTS

10.2. WIFI INSTALLATION



10.21 Open the cover of the WiFi box.



10.22 Cut the flange.



10.23 Disconnect the cables.

11.24 Pass the cable through the cable gland from the inside outwards.

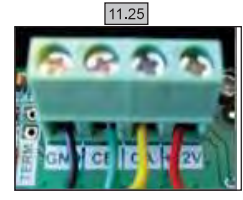

10.25 Connect the cables again in the WiFi box.

11. COVER

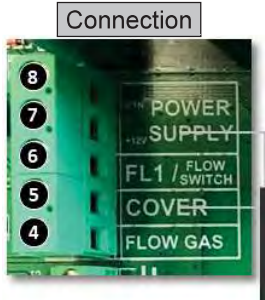

Cover 5 & 7

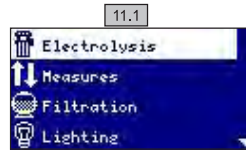

11.1 Cover: Connection of automatic cover.

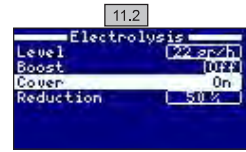

11.2 Reduction of chlorine production (as a percentage), when the pool cover is closed. With the cover closed it is not necessary for the system to run at 100%. Use this parameter to regulate the optimal amount of chlorine produced.

12. FLOW SWITCH

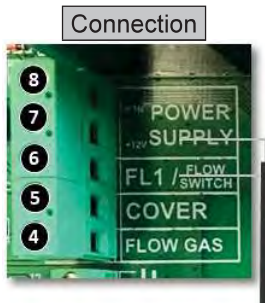

Flow switch 6 & 7

Input for mechanical security **flow switch**. It stops the electrolysis and dosing pumps if there is no water flow.

It is possible to add an external flow switch to the system. Connect as shown in the illustration and contact your installer to activate it. The titanium cell includes a gas flow sensor, and you can combine the two for better control.

13. VARIABLE SPEED PUMP

Connection

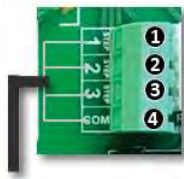

VARIABLE SPEED PUMP

- ① Slow
- ② Medium
- ③ Fast
- ④ Common

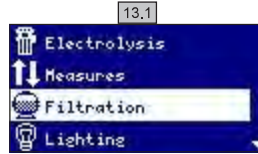

13.1 Variable Speed Pump: to install a variable speed pump contact your installer.



13.2 – 13.4 Once the pump has been connected, you can assign a different speed individually to each filtration period

S: slow, M: medium and F: fast.



13.5 Filter cleaning: to clean a filter with a variable speed pump, you should use the 'fast' speed setting.

14. DESCRIPTION OF MESSAGES ALARMS

P1/P2	Operating cell polarity. The cell changes polarity automatically to clean itself.
Lgt	Lighting is on.
Cov	Cover detector indicates that it is closed. Production will reduce automatically to the value configured in the electrolysis menu.
F1	Lack of water flow in the installation. Monitor the flow switches and check that the pressure is correct.
Low	Production of the device is not reaching the desired level. This can be due to various factors <ul style="list-style-type: none"> - Lack of salt - Scaled-up cell - Consumed cell (check the hours counter) - Low water temperature
AL3	Maximum time exceeded for acid dosing. Check pH readings, calibration and verify that the acid tank is not empty. To reset the alarm press the 'Back' key.

USE ONLY GENUINE REPLACEMENT PARTS

NOTES

GARANTIE LIMITÉE

Les produits Kripsol sont garantis contre tous défauts de fabrication ou de matière pendant **2 ans**, à compter de la date d'achat. Toute demande d'application de la garantie devra s'accompagner de la preuve d'achat portant mention de la date. Nous vous conseillons donc de conserver votre facture.

Dans le cadre de sa garantie, Kripsol choisira de réparer ou de remplacer les produits défectueux, sous condition d'avoir été utilisés selon les instructions du guide correspondant, de n'avoir subi aucune modification et de ne comporter que des pièces et composants d'origine. La garantie ne couvre pas les dommages dus au gel et aux produits chimiques. Tous les autres coûts (transport, main-d'œuvre, etc.) sont exclus de la garantie.

Kripsol ne pourra être tenu pour responsable des dommages directs ou indirects résultant d'une installation, d'un raccordement ou d'une utilisation incorrects du produit.

Pour toute demande de bénéfice de la garantie et de réparation ou remplacement d'un article, contacter votre revendeur.

Le retour de l'équipement en usine ne sera accepté qu'avec notre accord préalable.

Les pièces d'usure ne sont pas couvertes par la garantie.

Pièces d'usure : joints et revêtement des plaques de la cellule.

LIMITED WARRANTY

All Kripsol products are covered for manufacturing defects or material defects for a warranty period of **2 years** from the date of purchase. Any warranty claim should be accompanied by proof of purchase, indicating date of purchase. We would therefore advise you to keep your invoice.

The Kripsol warranty is limited to repair or replacement, as chosen by Kripsol, of the faulty products, provided that they have been subjected to normal use, in compliance with the guidelines given in their user manuals, provided that the products have not been altered in any way, and provided that they have been used exclusively with Kripsol parts and components. The warranty does not cover damage due to frost or chemicals. Any other costs (transport, labour, etc.) are excluded from the warranty.

Kripsol may not be held liable for any direct or indirect damage resulting from improper installation, improper connection, or improper operation of a product.

In order to make a claim under the warranty and in order to request repair or replacement of an article, please ask your dealer.

No equipment returned to our factory will be accepted without our prior written approval.

Parts damaged by wear and tear are not covered by the warranty.

Parts damaged by wear and tear: gasket and cell plate coating.

GARANTÍA LIMITADA

Todos los productos Kripsol están cubiertos contra los defectos de fabricación o de material por una garantía de **2 años** a partir de la fecha de la compra. Cualquier reclamación de garantía debe acompañarse con una prueba de compra, que indique la fecha de compra. Por consiguiente, le aconsejamos que conserve su factura.

La garantía Kripsol está limitada a reparaciones o reemplazos, según la elección de Kripsol, de los productos defectuosos, siempre que hayan sido sometidos a un uso normal, de acuerdo con las consignas indicadas en las guías del usuario, y siempre que los productos no hayan sido alterados de ninguna forma, y que se hayan utilizado exclusivamente con piezas y componentes Kripsol. La garantía no cubre averías debidas a la congelación o a productos químicos. Cualquier otro coste (transporte, mano de obra, etc.) está excluido de la garantía.

Kripsol declina toda clase de responsabilidad por cualquier daño directo o indirecto debido a la instalación incorrecta, la conexión incorrecta o una utilización incorrecta de un producto.

Para realizar una reclamación de garantía y para solicitar la reparación o el reemplazo de un artículo, póngase en contacto con su concesionario.

No se admitirá ninguna devolución de equipos a nuestra fábrica sin nuestra aprobación previa por escrito.

Las piezas sometidas a desgaste no están cubiertas por la garantía.

Las piezas de desgaste son: las juntas y el revestimiento de las placas de la célula.

GARANTIA LIMITADA

Os produtos KRIPSOL são garantidos contra quaisquer defeitos de fabrico ou de materiais por um período de **2 anos** a contar da data de compra. Qualquer pedido ao abrigo da garantia deve ser acompanhado pelo comprovativo de compra, indicando a data de compra. Portanto, aconselhamos que guarde a sua fatura.

No âmbito da garantia, a KRIPSOL decidirá reparar ou substituir os produtos defeituosos, na condição de que estes tenham sido utilizados de acordo com as instruções do manual correspondente, não tenham sido sujeitos a qualquer modificação e contenham apenas peças e componentes de origem. A garantia não cobre danos provocados pelo gelo ou por produtos químicos. Quaisquer outros encargos (transporte, mão-de-obra, etc.) estão excluídos da garantia.

A KRIPSOL não pode ser responsabilizada por quaisquer danos resultantes, direta ou indiretamente, de instalação incorrecta, ligações incorrectas ou utilização incorrecta de um produto.

Para apresentar um pedido ao abrigo da garantia e para solicitar reparação ou substituição de um artigo, é favor contactar o seu revendedor.

Nenhum equipamento devolvido à nossa fábrica será aceite sem a nossa prévia aprovação por escrito.

As peças de desgaste não são abrangidas pela garantia.

Peças de desgaste: juntas e revestimento das placas da célula.

BESCHRÄNKTE GARANTIE

Für ALLE Produkte von KRIPSOL gilt ab Kaufdatum eine **2-jährige** Garantie auf Herstellungs- oder Materialfehler. Zur Geltendmachung der Garantie legen Sie bitte den Kaufnachweis mit dem Kaufdatum vor. Daher empfehlen wir Ihnen, den Kaufbeleg gut aufzubewahren.

Die von KRIPSOL gewährte Garantie beschränkt sich nach KRIPSOLs Wahl auf die Reparatur oder den Ersatz der mangelhaften Produkte, vorausgesetzt, dass diese entsprechend den in der Benutzeranleitung gemachten Anweisungen einer normalen Benutzung unterzogen wurden, auf keinerlei Weise verändert wurden und ausschließlich aus Originalbau- und -ersatzteilen von KRIPSOL bestehen. Auf Frost und Chemikalien zurückzuführende Schäden sind von der Garantie ausgeschlossen. Alle anderen Kosten (Transport, Arbeitszeit etc.) sind von der Garantie ausgeschlossen.

KRIPSOL haftet nicht für direkte oder indirekte Schäden, die durch unsachgemäße Installation bzw. fehlerhaften Anschluss oder Betrieb des Produkts entstehen.

Um einen Garantieanspruch geltend zu machen und Reparatur oder Ersatz eines Artikels anzufordern, wenden Sie sich bitte an Ihren Händler.

Ohne unsere vorherige schriftliche Zustimmung nehmen wir keine an unser Werk gesendeten Geräte an.

Verschleißteile sind von der Garantie ausgeschlossen.

Verschleißteile: Dichtungsscheiben und Beschichtung der Zellenplatten.

BEPERKTE GARANTIE

Voor alle Kripsol-producten geldt een garantie van **2 jaar** vanaf de aankoop voor alle materiaal- of fabricagefouten. Indien u gebruik wilt maken van deze garantie, moet u het aankoopbewijs waarop de aankoopdatum vermeld staat meesturen. We raden u daarom aan uw factuur te bewaren.

De garantie van Kripsol beperkt zich tot het herstellen of vervangen, naar keuze van Kripsol, van defecte producten, voor zover deze in normale gebruiksomstandigheden en in overeenstemming met de instructies van de gebruikershandleiding werden gebruikt en voor zover deze niet werden gewijzigd en uitsluitend werden gebruikt met Kripsol-onderdelen en -componenten. De garantie geldt niet voor schade als gevolg van vorst en chemicaliën. Alle andere kosten (transport, arbeidsloon, enz.) zijn uitgesloten van garantie.

Kripsol kan niet verantwoordelijk worden gehouden voor directe of indirecte schade die voortvloeit uit verkeerde installatie, verkeerde aansluiting of verkeerd gebruik van een product.

Om uw recht op garantie uit te oefenen en de reparatie of de vervanging van een product aan te vragen, moet u contact opnemen met uw leverancier.

Geen enkel apparaat dat naar onze fabriek wordt teruggestuurd, zal worden aanvaard zonder onze voorafgaande schriftelijke goedkeuring.

De garantie geldt niet voor slijtdelen.

Slijtdelen: afdichtingen en bekleding van de plaatjes van de cel.

GARANZIA LIMITATA

Tutti i prodotti KRIPSOL sono garantiti contro i difetti di produzione o i difetti sul materiale per un periodo di **2 anni** dalla data d'acquisto. Ogni eventuale richiesta di intervento in garanzia deve essere accompagnata da una prova d'acquisto riportante la data. Si consiglia, pertanto, di conservare la fattura o lo scontrino fiscale.

KRIPSOL si riserva la scelta se riparare o sostituire i prodotti difettosi a condizione che questi siano stati utilizzati secondo le istruzioni riportate nel manuale d'uso, non siano stati modificati e non presentino parti e componenti non originali. La presente garanzia non copre i danni dovuti al gelo o all'azione di prodotti chimici. Ogni altro costo (trasporto, manodopera, ecc.) è escluso dalla presente garanzia.

KRIPSOL non è da ritenersi responsabile per qualsiasi danno, diretto o indiretto, derivante da un'installazione non corretta, da collegamenti erronei o da un uso improprio del prodotto.

Per usufruire della presente garanzia e richiedere un intervento di riparazione o sostituzione di un articolo, contattare il proprio rivenditore.

Nessun prodotto può essere rinviato direttamente in fabbrica senza la nostra preliminare autorizzazione.

Le parti usurabili non sono coperte da garanzia.

Parti usurabili: giunti e rivestimenti delle piastre della cella.

ОГРАНИЧЕННАЯ ГАРАНТИЯ

Продукты Kripsol имеют гарантию от дефектов изготовления или материалов в течение **2 лет** с даты покупки. Любой запрос на применение гарантии должен сопровождаться документом о подтверждении покупки с указанием даты. Рекомендуем сохранить чек.

В рамках предоставляемой гарантии компания Kripsol решит отремонтировать или заменить бракованные продукты, если они были использованы в соответствии с инструкциями соответствующего руководства, не подвергались каким-либо изменениям и содержали только оригинальные детали и составные части. Гарантия не распространяется на повреждения, вызванные воздействием низких температур и химических веществ. Все иные затраты (транспортировка, оплата труда и т. д.) из гарантии исключены.

Компания Kripsol не несет ответственности за прямые или косвенные убытки, возникшие в результате неправильной установки, подключения или использования продукта.

По любому вопросу о гарантии и ремонте или замене изделия обращайтесь к своему дилеру.

Возврат оборудования на завод будет принят только с нашего предварительного согласия.

На изнашиваемые детали гарантия не распространяется.

К изнашиваемым деталям относятся прокладки и покрытие пластин ячейки.