

EDG SERIES

ABS ΣΧΑΡΕΣ ΠΥΘΜΕΝΑ
ABS FRAMES & GRATES

ACQUA SOURCE™



EDG-802, EDG-902

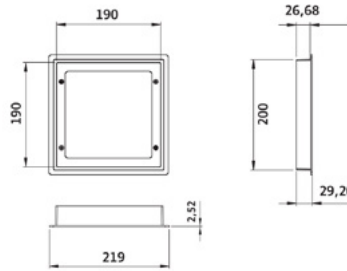

EDG-802

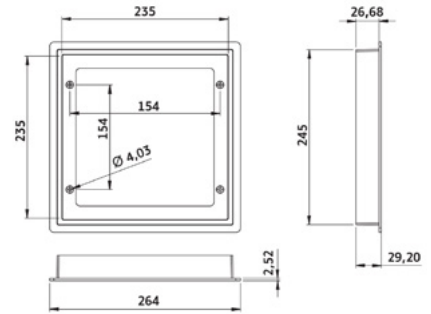

EDG-902

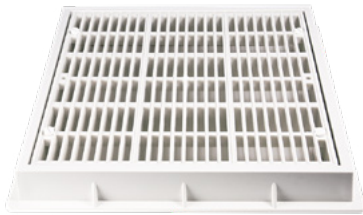

EDG-265

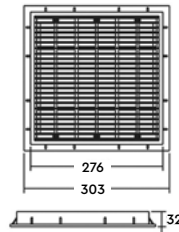

Κωδικός Code	Μέγεθος Size	Εγκατάσταση Installation	Υλικό Material
EDG-802	8"χ8"	Σκυρόδεμα Concrete	ABS
EDG-902	9"χ9"	Σκυρόδεμα Concrete	ABS
EDG-265	11"χ11"	Σκυρόδεμα Concrete	ABS

DG/AV

ABS ΣΧΑΡΕΣ ΠΥΘΜΕΝΑ
ABS FRAMES & GRATES

ACQUA SOURCE™

ΝΕΑ ΠΡΟΣΘΗΚΗ
NEW ENTRY



DG/AV-902

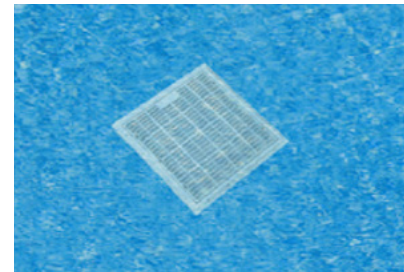
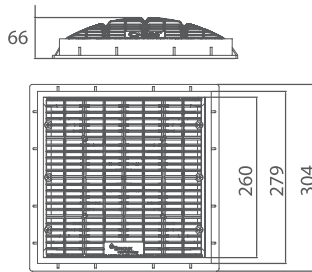

DG/AV-212

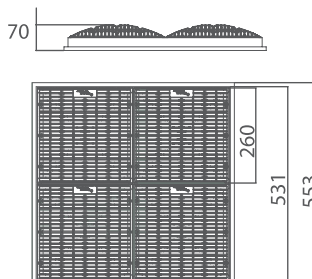

Κωδικός Code	Μέγεθος Size	Εγκατάσταση Installation	Υλικό Material	Παροχή Flow rate (L/min)
DG/AV-902	9"χ9"	Σκυρόδεμα Concrete	ABS	900
DG/AV-212	21"χ21"	Σκυρόδεμα Concrete	Ανοξ. ΑΙSΙ-316 σκελετό & ABS S.S. AISI-316 frame & ABS	3600